



Kooltherm® K10 FM Soffit Board

INSULATION FOR CONCRETE SOFFITS



- Super high performance rigid thermoset modified resin insulation
- Fibre-free insulation core
- Fire-rated to FM Global approval (Class No. 4880: Class1)
- Group 1 BCA fire classification
- Resistant to the passage of water vapour
- Easy to handle and install
- Ideal for new build and refurbishment
- Rodent, mould and fungi resistant
- CFC/HCFC-free with zero Ozone Depletion Potential (ODP)
- Compliant with AS/NZS 4859.1:2002



Low Energy –
Low Carbon Buildings

Kooltherm® K10 FM Soffit Board

Typical Design Details

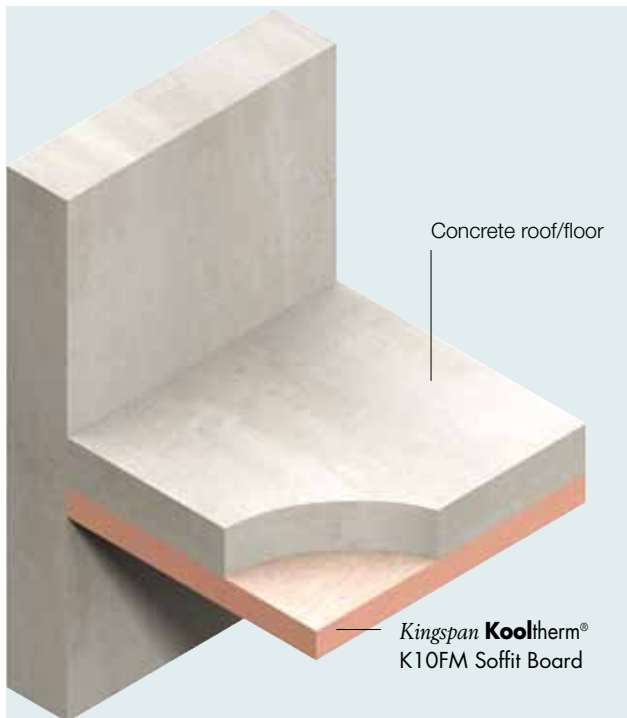

Figure 1 Concrete soffit floor installation

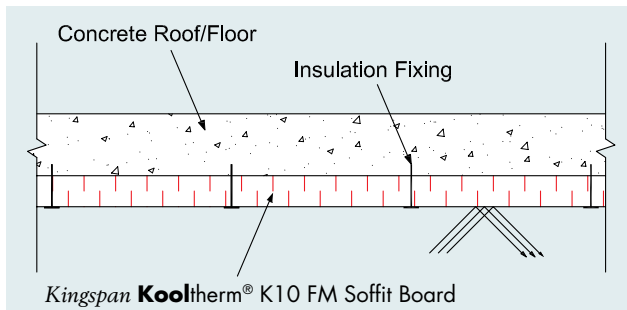

Figure 2 Installation Details

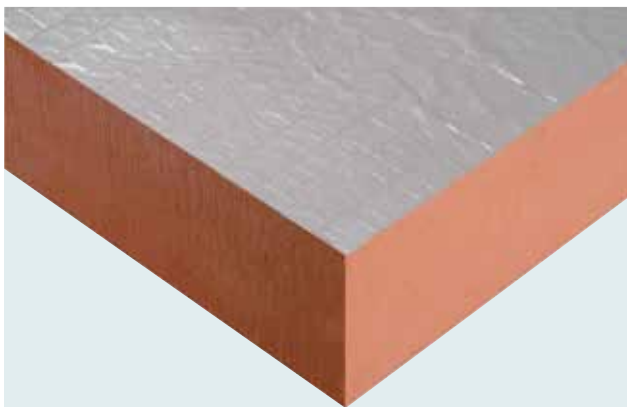

Figure 3 Super high performance Kingspan Kooltherm K10 FM Soffit Board

Application Options

- Flat concrete roof (Soffit)
- Concrete floor (Soffit)

Product Description

Kingspan Kooltherm® K10 FM Soffit Board is a super high performance, fibre-free rigid thermoset modified resin insulation core, sandwiched between an upper tissue-based facing and a lower facing of highly reflective aluminium foil autohesively bonded to the insulation core during manufacture.

Kingspan Kooltherm® K10 FM Soffit Board is manufactured without the use of CFCs/HCFCs and has zero Ozone Depletion Potential (ODP).



Product Data

Thermal Conductivity (λ -value)*	0.020 W/mK (Board thickness \geq 45 mm) 0.021 W/mK (Board thickness 25 - 44 mm) 0.023 W/mK (Board thickness < 25 mm)
Emittance (Foil Face)	E0.14
Board Dimensions	2270 mm x 1200 mm (2.72 m ²)
Board Thickness	25, 30, 40, 50, 60, 70, 75, 80, 90 mm
Typical Weight	2.7 kg - 10.3 kg per board depending on thickness and typical density

* The λ -values quoted are in accordance with the principles in the Harmonised European Standard BS EN 13166:2001 (Thermal insulation products for buildings – Factory made products of phenolic foam (PF) – Specification) using so called 90 / 90 principles. Comparison with alternative products may not be appropriate unless the same procedures have been followed.

Specification Guide

Kingspan Kooltherm® K10 FM Soffit Board

The soffit insulation shall be *Kingspan Kooltherm®* K10 FM Soffit Board ___ mm thick CFC/HCFC free rigid insulation comprising a high performance thermoset insulation core with autohesively bonded facings on both sides manufactured to the highest standards under quality control systems approved by ISO 9001:2000 by Kingspan Insulation Pty Limited and shall be applied in accordance with the instructions issued by them.

Thermal Performance

Product R-value

Product Thickness	Product R-value
25 mm	R1.2
30 mm	R1.4
40 mm	R1.9
50 mm	R2.5
60 mm	R3.0
70 mm	R3.5
75 mm	R3.8
80 mm	R4.0
90 mm	R4.5

Total R-value

Roof Application, no ceiling (150 mm concrete)	Heat flow in	Heat flow out
25 mm Board	R _T 2.1	R _T 1.6
30 mm Board	R _T 2.4	R _T 1.8
40 mm Board	R _T 2.8	R _T 2.3
50 mm Board	R _T 3.4	R _T 2.9
60 mm Board	R _T 3.9	R _T 3.4
70 mm Board	R _T 4.4	R _T 3.9
75 mm Board	R _T 4.7	R _T 4.1
80 mm Board	R _T 4.9	R _T 4.4
90 mm Board	R _T 5.4	R _T 4.9

Roof Application, suspended ceiling (150 mm concrete)	Heat flow in	Heat flow out
25 mm Board	R _T 2.4	R _T 1.9
30 mm Board	R _T 2.6	R _T 2.2
40 mm Board	R _T 3.1	R _T 2.6
50 mm Board	R _T 3.7	R _T 3.2
60 mm Board	R _T 4.2	R _T 3.7
70 mm Board	R _T 4.7	R _T 4.2
75 mm Board	R _T 5.0	R _T 4.5
80 mm Board	R _T 5.2	R _T 4.7
90 mm Board	R _T 5.7	R _T 5.2

Unenclosed Sub-floor Application (150 mm concrete)	Heat flow in	Heat flow out
25 mm Board	R _T 1.4	R _T 1.5
30 mm Board	R _T 1.7	R _T 1.7
40 mm Board	R _T 2.2	R _T 2.2
50 mm Board	R _T 2.8	R _T 2.8
60 mm Board	R _T 3.3	R _T 3.3
70 mm Board	R _T 3.8	R _T 3.8
75 mm Board	R _T 4.0	R _T 4.0
80 mm Board	R _T 4.3	R _T 4.3
90 mm Board	R _T 4.8	R _T 4.8

Enclosed Sub-floor Application (150 mm concrete)	Heat flow in	Heat flow out
25 mm Board	R _T 2.2	R _T 2.8
30 mm Board	R _T 2.4	R _T 3.0
40 mm Board	R _T 2.9	R _T 3.5
50 mm Board	R _T 3.5	R _T 4.1
60 mm Board	R _T 4.0	R _T 4.6
70 mm Board	R _T 4.5	R _T 5.1
75 mm Board	R _T 4.7	R _T 5.3
80 mm Board	R _T 5.0	R _T 5.6
90 mm Board	R _T 5.5	R _T 6.1

The R-values shown are Total R-values for the building element as required by the Energy Provisions of the Building Code of Australia. Kingspan Kooltherm® products are manufactured, tested and packaged in conformance with AS/NZS 4859.1:2002 - Amdt 1. The contribution of the product Total R-values depends on installation and environmental conditions. The R-value will be reduced in the event of the accumulation of dust on the upward facing surfaces and in those cavities that are ventilated.

Kooltherm® K10 FM Soffit Board

Standards and Approvals

Kingspan Kooltherm® K10 FM Soffit Board is manufactured to the highest standards and certified under the following management systems:

Standard	Management System
BS EN ISO 9001: 2008/ I.S. EN ISO 9001: 2008	Quality Management
BS EN ISO 14001 : 2004/ I.S. EN ISO 14001 : 2004	Environmental Management
BS OHSAS 18001: 2007/ I.S OHSAS 18001: 2007	Health and Safety Management

Product Testing

Characteristic	Test Method	Result
Thermal Conductivity (λ -value)	BS EN 13166: 2001	0.020 W/mK (Board thickness \geq 45 mm)
		0.021 W/mK (Board thickness 25 - 44 mm)
		0.023 W/mK (Board thickness < 25 mm)
Compressive Strength	BS EN 826: 1996	Typically exceeds 100 kPa at 10% compression
Water Vapour Resistance	BS 12086: 1997	> 100 MN.s/g

Fire Performance

Test	Test Method	Result
Ignitability, Flame spread Heat release, Smoke release	AS 1530.3	0/0/0/0-1
Group Classification	AS/NZS 3837	Group 1
FM Class No. 4880*	UBC 26-3	Class 1
Surface Spread of Flame	BS476 Part 6 & 7	Class 0

* This approval is valid for ceiling / soffit installation only, with non-combustible walls and a floor to ceiling / soffit height restriction of 9.1m. Please contact us for correct installation instructions.

Durability

If correctly applied, Kingspan Kooltherm® products can be expected to have a long life of service.

Their durability depends on the supporting structure and the conditions of its use.

Kingspan Kooltherm® products are warranted for a period of 10 years for both residential and commercial installations.*

* Subject to the terms of the complete Kingspan Kooltherm® warranty document which is available upon request or downloadable from www.kingspaninsulation.com.au.

Environmental Data

Aspect	Characteristic
Recycled/Renewable Content	1.3%
Recyclability	Non-contaminated insulation site waste is recyclable, but there are currently no facilities in Australia to process returned material
Re-usability	Re-usable if removed with care (long term of service expected)
Water Use	No water used in Kingspan Insulation's manufacturing process
Blowing Agent Global Warming Potential (GWP)	Manufactured with a blowing agent that has low GWP
Blowing Agent Ozone Depletion Potential (ODP)	Manufactured with a CFC/HCFC-free blowing agent that has zero ODP
Packaging	Contains 0% recycled product Polythene wrap and EPS skids 100% recyclable

Installation Instructions

Fixing Directly to Concrete Soffits

Kingspan **Kooltherm**® K10 FM Soffit Board can be fully restrained to a concrete soffit by the use of minimum 11 No. appropriate insulation fasteners with a minimum head diameter of 35 mm.

1. The fasteners should be evenly distributed over the whole area of the board and must offer a minimum 40 mm penetration into a solid substrate.
2. Board joints can be either staggered or squared and taped with a minimum 48 mm wide appropriate aluminium foil tape. 4 No. fasteners along each length - no less than 50 mm - no more than 150 mm from edge of board, 3 No. fasteners along the middle (Offset from edge positions as per diagram).
3. Where the board may be subject to external wind pressure, the requirement for additional fixings should be assessed in accordance with appropriate Australian wind load standards.

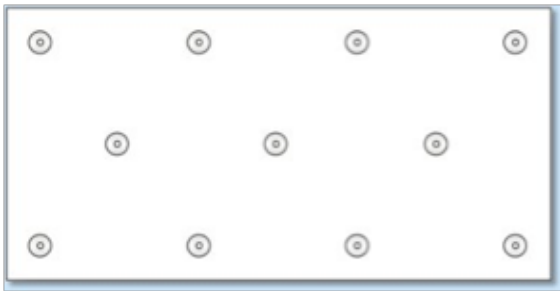

Figure 4 Fastener pattern (11 No. per board)
Board size to 2.270 x 1.200 - 4.03 fixings / m²

Why 11 fixings?

Best practice determines that any rigid board insulation, not just **Kingspan Kooltherm**® K10 FM Soffit Board, should be fixed with 11 mechanical fixings for very good reasons:

- There will always be differential expansion and contraction between any rigid insulation material and adjacent building products due to varying moisture content and temperature.
- In any concrete forming, there will be an uneven surface throughout the slab.
- Where concrete formwork is joined it is normal to have ridges of up to 3 mm which make the concrete surface uneven.
- An insulation board held horizontally may bow like any other sheetmaterial under its own weight.

Using 11 fixings ensures that the insulation board has a strong and permanent fix under the concrete soffit and that it is not compromised by any of the above issues. It also provides a proven robust fire safe solution.

These best practice recommendations are a result of over 30 years of Kingspan Insulation experience in soffit applications.

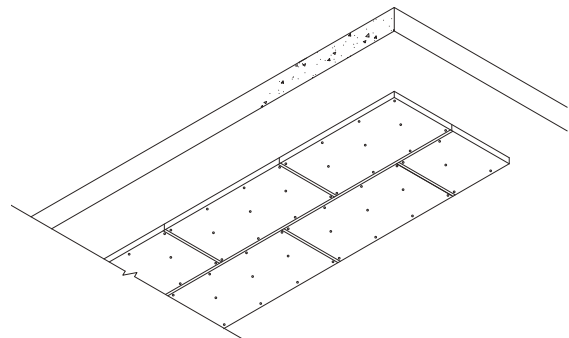

Figure 5 Board joints staggered

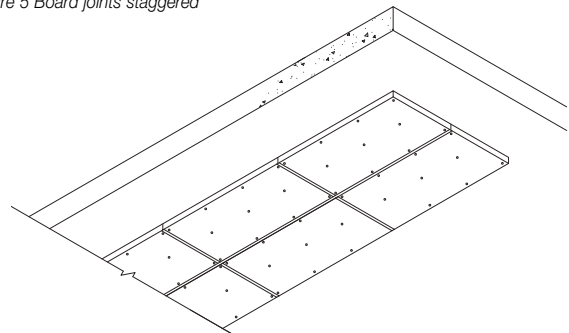

Figure 6 Board joints squared

Kooltherm® K10 FM Soffit Board

Installation Instructions (continued)

Fixing to Timber Battens/Furring Channels

1. Alternatively, a treated softwood batten/furring channel lay-out may be adopted if there is an uneven surface or mechanical services present and direct fixing is not possible.
2. 50 mm x 25 mm battens/furring channels should be placed at 600 mm centres to coincide with the edges/centres of the boards.
3. The battens/furring channels should be fixed to the soffit by the use of a suitable fixing method e.g. shot-fire may be considered.
4. *Kingspan Kooltherm® K10 FM Soffit Board* should then be fixed to the treated timber battens/furring channels using suitable fixings. These should be placed at maximum 300 mm (maximum 200 mm when using nails into timber) in rows not greater than 600 mm apart.
5. Where the board may be subject to external wind pressure, the requirement for additional fixings may need to be assessed in accordance with appropriate wind load standards.

For advice on ancillary materials, such as fixings and tapes please contact our Technical Services Department.



General

Cutting

Cutting should be carried out either by using a fine toothed saw, or by scoring with a sharp knife, snapping the board over a straight edge and then cutting the facing on the other side. Ensure accurate trimming to achieve close-butting joints and continuity of insulation.

Taping

For all fixing methods board joints should be taped with a minimum 48 mm wide foil tape.

1. Firstly, ensure that the climate conditions are suitable for the tape being used as well as the product the tape is to be applied too.
2. The surface of the *Kingspan Kooltherm*[®] to which aluminium foil tape is being applied, should be free of dust, dirt or oils. In any case, the surface should be cleaned with a dry cloth before application of the tape.
3. The release liner on the tape should be removed 300 - 600 mm at a time and the adhesive face pressed firmly onto the insulation facing. Care should be taken not to stretch the tape tightly as this will create buckles and voids in the contact area.
4. Care must also be taken to apply the tape over the centre of the joint so that there is adequate area on both sides of the joint for the tape to bond. Uneven width distribution also puts additional shear stress on the smaller side of the butt joint.
5. The tape should then be wiped firmly from the centre out (like wallpaper) with a plastic squeegee. The more pressure that is applied, the more surface contact will be reached, therefore, the greater the bond surface.
6. The tape should then be cut and fitted with a knife and scissors. The same wiping instructions should then be used as above.

In the absence of other protection exposed board edges should be protected by a suitable foil tape with a minimum 48 mm wide overlap onto the board face (see Figure 7) or alternatively use a UPVC c-section.

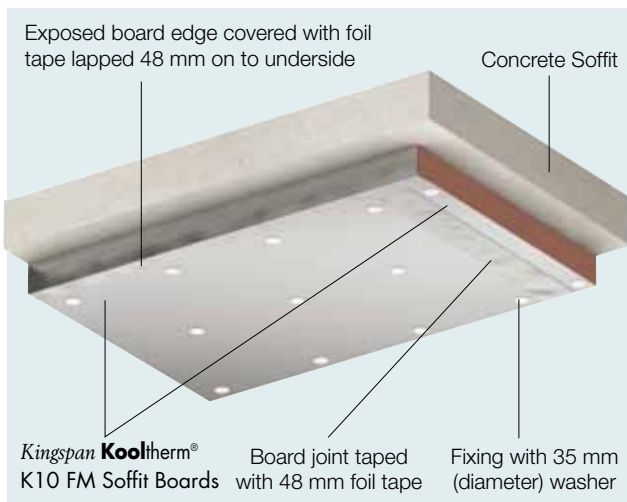

Figure 7

Packaging

According to quantity, the boards are supplied in packs, labelled and shrink-wrapped in polythene.

Handling and Storage

Storage

The packaging of *Kingspan Kooltherm*[®] should not be considered adequate for long term outdoor protection. Ideally boards should be stored inside a building. If, however, outdoor storage cannot be avoided then the boards should be stacked clear of the ground and covered with an opaque polythene sheet or weatherproof tarpaulin. Boards that have been allowed to get wet should not be used.

Resistance to Solvents

The insulation core is resistant to short-term contact with petrol and with most dilute acids, alkalis and mineral oils. However, it is recommended that any spills be cleaned off fully before the boards are installed. Ensure that safe methods of cleaning are used, as recommended by suppliers of the spilt liquid. The insulation core is not resistant to some solvent-based adhesive systems, particularly those containing methyl ethyl ketone. Adhesives containing such solvents should not be used in association with this product. Damaged boards or boards that have been in contact with harsh solvents or acids should not be used.

OH & S

Kingspan Insulation products are chemically inert and safe to use. A Product Safety Information sheet is available from Kingspan Insulation Pty Ltd.

Please note that the reflective surfaces on this product are designed to enhance their thermal performance. As such, they will reflect light as well as heat, including ultraviolet light. Therefore, if these boards are being installed during bright or sunny weather, it is advisable to wear UV protective sunglasses or goggles and if the skin is exposed for a significant period of time, to protect bare skin with a UV block sun cream.

Contact Details

General Enquiries

Tel: 1300 247 235

Email: info@kingspaninsulation.com.au

Kingspan Insulation Pty. Ltd. reserves the right to amend product specifications without prior notice. The information, technical details and fixing instructions etc. included in this literature are given in good faith and apply to uses described. Recommendations for use should be verified as to the suitability and compliance with actual requirements, specifications and any applicable laws and regulations. For other applications or conditions of use, Kingspan Insulation offers a Technical Advisory Service the advice of which should be sought for uses of Kingspan Insulation products that are not specifically described herein. Please check that your copy of the literature is current by contacting us or visiting www.kingspaninsulation.com.au



Kingspan Insulation Pty Ltd

Tel: 1300 247 235

Email: info@kingspaninsulation.com.au

www.kingspaninsulation.com.au