

SikaFuko® Swell 1

(formerly Sika Injectoflex HPM)

Hydrophilic, swellable hose for sealing construction joints in watertight structures

Product Description

Swellable and injectable hose to seal construction joints in watertight structures against water and seawater ingress.

Uses

SikaFuko® Swell 1 is used to seal construction joints in watertight structures against water and salt water ingress. It is cast into the construction joints with the concrete. To seal the joint, any penetrating water in a first phase “activates” the three exterior swelling strips on the surface of the SikaFuko® Swell 1 Hose, which start to swell. The resulting pressure forces the water to try and find an alternative and longer way through the structure, and in the process this effectively seals the joint with the reduction of the water pressure.

When it is necessary, in a second phase, the system can be injected, which again causes the water to attempt to find an alternative route and so effectively seals the joint again.

It is also possible when necessary to reseal the joint against any future water penetration by re-injection, provided that only acrylic resin or microfine cement is used for the initial injection.

Characteristics / Advantages

- Accurately targeted waterproofing in 2 distinctly separate phases
Phase 1: Swelling by water- or salt water penetration
Phase 2: By injection and re- injection at a later stage (if necessary)
- Injectable with Sika acrylic and polyurethane resins or microfine cement suspensions.
- Economical, easy to install
- Suitable for many different structures and construction methods

Tests

Approval / Standards

Hygiene-Institut Gelsenkirchen: Scientific examination according to water-hygienic aspects (27.11.08).



Product Data

Form

Packaging	SikaFuko® Swell 1 is supplied as a complete kit in a cardboard box containing: <ul style="list-style-type: none">- 40 m SikaFuko® Swell 1- 6 Injection Port Assemblies (Double Shutter-Packers) with connection pieces and connection hoses- 200 fixing clips- 6 corner connection pieces <p>Note: Additional corner connection pieces and fixing clips can also be ordered separately.</p>
------------------	--

Storage

Storage Conditions / Shelf Life	48 months from date of production if stored in undamaged, unopened and sealed original packaging, in dry conditions at temperatures between +5°C and +35°C.
--	---

Technical Data

Chemical Base	Black inner core: EPDM Red parts: <ul style="list-style-type: none">- Non swelling round profiles: Closed cell profiles to keep the injection discharge holes closed whilst the concreting works are in progress Yellow parts: <ul style="list-style-type: none">- Swelling rectangular profile strips: Combination of hydrophilic swelling resins and rubber
Change of Volume	Swelling parts (yellow): 7 days in salt water: ≥ 150% (DIN 53521) 7 days in tap water: ≥ 300%

Mechanical / Physical Properties

Shore A Hardness	Black inner core: 80 +/- 5 (DIN 53505) Yellow hydrophilic swelling strips: 75 +/- 5 (DIN 53505)
Elongation at Break	Black inner core: ≥ 100% (DIN 53504) Yellow hydrophilic swelling strips: ≥ 250% (DIN 53504)

System Information

System Structure

System Configuration

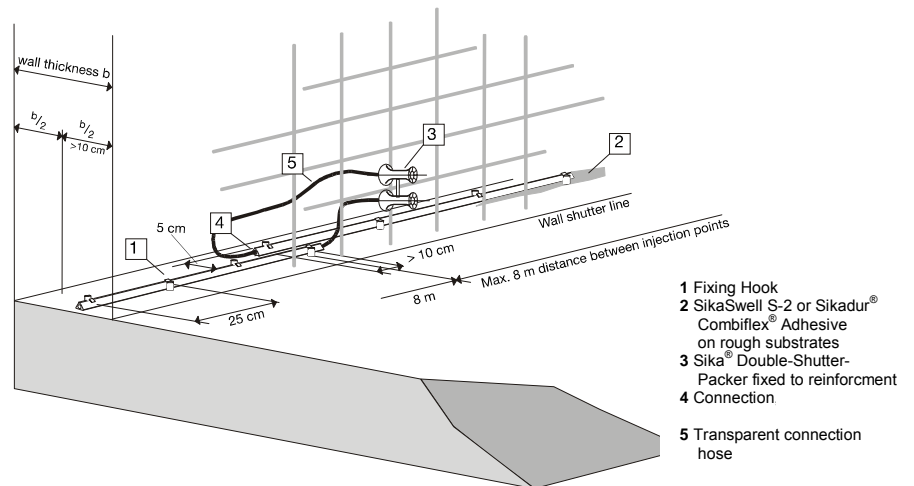

- 1 Fixing Hook
- 2 SikaSwell S-2 or Sikadur® Combiflex® Adhesive on rough substrates
- 3 Sika® Double-Shutter-Packer fixed to reinforcement
- 4 Connection
- 5 Transparent connection hose

SikaFuko® Swell 1

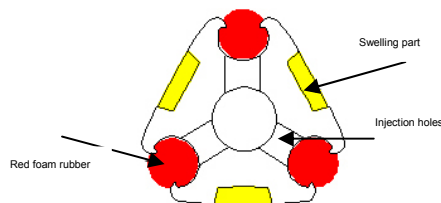

- Inner core made from black, non swelling rubber
- 3 yellow swellable strips
- 3 red, round rubber profiles used to cover the injection holes

Cross section width ~ 23 mm

The system configuration as described must be fully complied with and may not be changed.

SikaFuko® Swell 1 Fixing Clips:

Yellow plastic clips with fixing pins to suit the size of the injection hose.
Requirement: 5 clips per 1 metre.

SikaFuko® Swell 1 Double-Shutter-Packers:

Coloured red / green, with tie wires for easy and fast fixing to the reinforcement. Each of the two connection hoses can be turned to align with the shutters. The transparent connecting hoses ~ 60 cm length are fixed to the shutter-packers using the fitted connection pieces.

SikaSwell® S-2:

One-part elastic adhesive sealant which swells in contact with water. For rough, dry or 'mat damp' substrates. Apply in beads to the substrate (bead-diameter dependent on the substrate roughness). Press the SikaFuko® Swell 1 hose into the freshly applied sealant. Allow the SikaSwell® S-2 to harden for 2 - 3 hours before placing fresh concrete.

Please also refer to the SikaSwell® S-2 Product Data Sheet.

Sikadur®-31 Adhesive:

Two-part rigid adhesive mortar for rough, dry or 'mat damp' substrates

Material consumption: ~ 0.1 - 0.3 kg/m dependent on the substrate profile.

Please also refer to the Sikadur®-31 Product Data Sheet.

Application Details

Substrate Quality The substrate must be sound, clean, dry or 'mat damp', free from all surface contaminants.

Substrate Preparation All loose particles, release agents, cement laitance, paint, rust and any other poorly adhering materials must be removed by suitable mechanical preparation techniques.

Surfaces which are extremely rough can tend to allow leaks under the hose later on. To prevent this, you shall place a narrow wooden board into the fresh concrete surface of the previous pour, to create a groove into which the *SikaFuko® Swell 1* Hose can be securely placed.

Application Conditions / Limitations

Substrate Temperature Dependent on the fixing method / adhesive which has been selected. Please refer to the relevant Product Data Sheets.

Ambient Temperature Dependent on the fixing method / adhesive which has been selected. Please refer to the relevant Product Data Sheet.

Substrate Moisture Content The substrate must be surface dry or 'mat damp'.

Application Instructions

Application Method / Tools

SikaFuko® Swell 1 Hose is fixed in lengths of maximum 8 metres. The end of each length must overlap by at least 10 cm and the distance between the overlapping ends must be at least 50 mm (see drawing page 3). Every 8 metres a *Sika® Double-Shutter-Packer* should be fixed, which provides access for injection into the previous and the following sections (the inlet and outlet are combined in the packer unit).

SikaFuko® Swell 1 Hose is always fixed on top and in the centre of the hardened concrete. The hose has to be placed in such a way that concrete cover of at least 10 cm is maintained, parallel to the surface of both the inner and outer formwork.

Fixing Methods:

Smooth, flat, dry or 'mat damp' surfaces (e.g. trowel finished concrete).

- With *SikaFuko® Swell 1* Fixing Clips

The clips are placed at a distance of max. 25 cm either directly into the still fresh concrete, or are later hammered into holes of 10 mm diameter, drilled into the hardened concrete. The Swell 1 hose should be placed under the clips just before placing the following concrete.

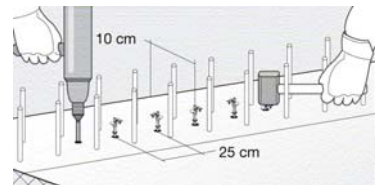
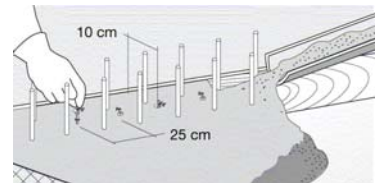

- With *SikaSwell® S-2*

Apply *SikaSwell® S-2* in a narrow bead (size of triangular section ~ 5 mm) to the substrate. The Swell 1 hose must be placed within a max. 30 minutes and pressed well into the fresh *SikaSwell® S-2* Sealant, until small quantities of the *SikaSwell® S-2* 'ooze-out' from both sides of the Swell 1 hose. Secure the hose-ends and at corners with fixing clips in addition to *SikaSwell® S-2*. Allow *SikaSwell® S-2* to harden for 2 - 3 hours before placing fresh concrete. Please also refer to the Product Data Sheet for *SikaSwell® S-2*.

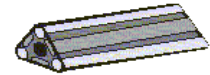
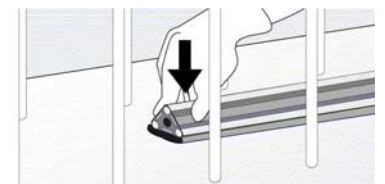
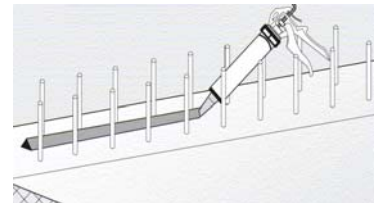

Max. 8 m

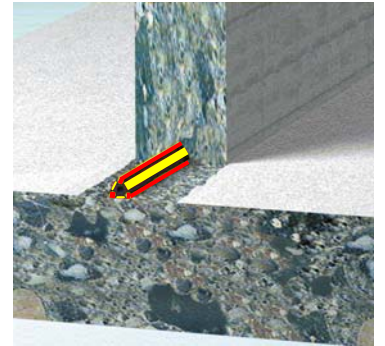

Rough, uneven, dry or “mat damp” substrates (e.g. scabbled concrete):

- With Sikadur®-31 Adhesive

The thoroughly mixed adhesive is applied the width of the hose onto the substrate. The Swell 1 hose is placed and pressed well into the fresh adhesive until small quantities of the adhesive ‘ooze-out’ from both sides of the hose. Allow the adhesive to harden for a few hours before placing fresh concrete. Please also refer to the Product Data Sheet of Sikadur®-31 Adhesive.

Other very, smooth dry surfaces (e.g. steel substrates) :

- Use SikaSwell® S-2 (see above)

Corners and edges:

At corners and edges, cut the SikaFuko® Swell 1 hose to a 45° mitre angle. Connect both hose sections flush with the corner connection piece. Fix the hose ends with clips set at short distances (2 - 5 cm) or carefully bond to the substrate. In a wide radius situation the Swell 1 hose can be bent around the corner.

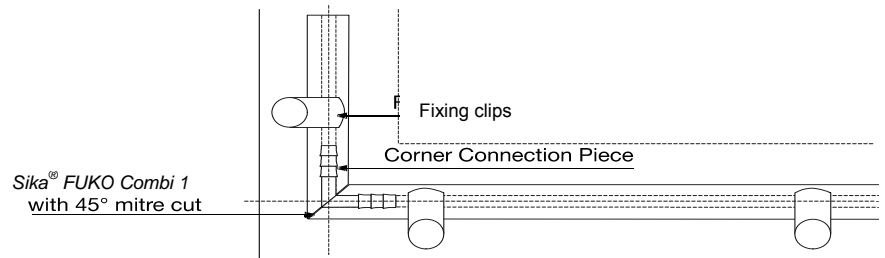
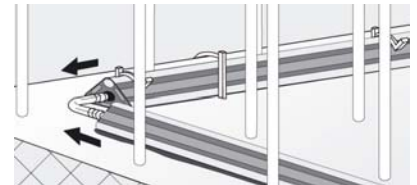

Injection Points:

At each of the 8 m overlaps, the connection to the injection-point has to be installed. This connection consists of the Sika® Double-Shutter-Packer, which has both an inlet and outlet opening complete with connecting hoses. The Double-Shutter-Packer is fixed vertically to the rebars with the tie wires so that it cannot be displaced. The level of the packers from the substrate must take into consideration the finished level (i.e. after floor screeds etc.). Vertical fixing of the packers results in better stability during concreting.

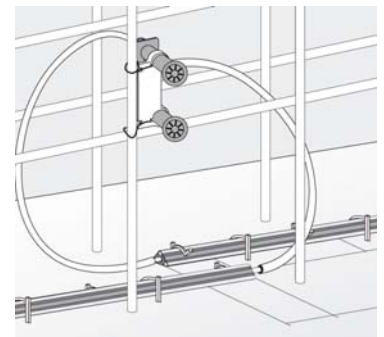

The packers can easily be adjusted to the shutter level simply by turning the two injector pipes. The cover-cones are then fixed to the shutter surface or taken through to allow for the finishings.

The attached flexible connection pipes are cut to size according to the specific requirements. The connection piece is inserted into the SikaFuko® Swell 1 hose.

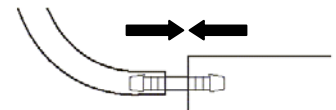

To assist installation the packers are bi-coloured (red and green). “Green” is preferably the entry point (for the following section), and “red” the exit, or shut-off (for the previous section). The red and green components are of identical dimensions and are interchangeable if necessary.

Note: Always detail the required location of the Double-Shutter-Packers in the drawings of the structure (for ease of any future injection requirements).

Concreting:

In order to maintain secure fixing of the *SikaFuko® Swell 1*, the connecting pipes and the packers, place a layer of mortar or fine concrete over them immediately before the start of the pour.

Typical mortar/fine concrete mix-designs

Typical Mortar Mix Design	
Cement content	400 kg/m ³
Aggregate-size	0 - 4 mm (0 - 8 mm)
Additive:	
Sika® Emulsion 93	30 - 60 kg/m ³

Typical Fine Concrete Mix Design	
Cement content	350 kg/m ³
Aggregate size	0 - 16 mm
Admixture	As for the concrete, e.g. Sikament® (W/C ratio < 0.50)

Injection:

When water reaches *SikaFuko® Swell 1* fixed with *SikaSwell® S-2*, water tightness is achieved by the swelling action and the resulting pressure increase, provided the concrete is homogeneous, well compacted and without cracks. This pressure increase takes some time (please refer to the *SikaSwell® S-2* Product Data Sheet). The injection shall not be carried out too soon or the initial swelling process may be delayed or even prevented.

If some localised water leakage still occurs then this may be due to:

- Inadequate substrate preparation
- Errors during concrete placement (insufficient compaction)
- Cracks
- Excessive water pressure

In these situations the leaks can be stopped in a second phase by injection through the *SikaFuko® Swell 1* System into the surrounding concrete. This extends the water penetration path and watertightness is achieved.

Note: The concrete must be at least 4 weeks old before carrying out any injection work.

Suitable Injection Materials:

- Sika® InjectoCem-190
Pre-batched micro cement based.
- Sika® injection-29 New
Swellable acrylic injection resin

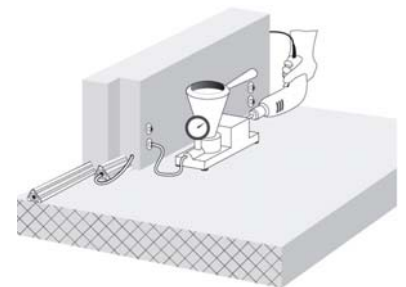

Cleaning of Tools	Clean all tools and application equipment with Sika® Colma-Cleaner immediately after use. Hardened / cured material (adhesive) can only be removed mechanically.
Notes on Application / Limitations	Do not use <i>SikaFuko® Swell 1</i> -System for expansion / movement joints. <ul style="list-style-type: none">- The three external yellow profile “strips” of the Swell 1 hose swell in contact with water, this does not happen immediately, but slowly and after several hours. However do not leave the Swell 1 hose for any length of time exposed in the open air or exposed to rain water (max. 24 hours as long as the water can drain away), as this could reduce the ability of the <i>SikaFuko® Swell 1</i> to swell in contact with water.
Value Base	All technical data stated in this Product Data Sheet are based on laboratory tests. Actual measured data may vary due to circumstances beyond our control.
Health and Safety Information	For information and advice on the safe handling, storage and disposal of chemical products, users shall refer to the most recent Material Safety Data Sheet containing physical, ecological, toxicological and other safety-related data.
Legal Notes	<p>The information, and, in particular, the recommendations relating to the application and end-use of Sika products, are given in good faith based on Sika's current knowledge and experience of the products when properly stored, handled and applied under normal conditions. In practice, the differences in materials, substrates and actual site conditions are such that no warranty in respect of merchantability or of fitness for a particular purpose, nor any liability arising out of any legal relationship whatsoever, can be inferred either from this information, or from any written recommendations, or from any other advice offered. The proprietary rights of third parties must be observed. All orders are accepted subject to our current terms and conditions of sale. Users should always refer to the most recent issue of the Australian version of the Product Data Sheet for the product concerned, copies of which will be supplied on request.</p> <p>PLEASE CONSULT OUR TECHNICAL DEPARTMENT FOR FURTHER INFORMATION.</p>



Sika Australia Pty Limited
www.sika.com.au

ABN: 12 001 342 329
Tel: 1300 22 33 48

